

Teaching Magnetic Levitation at Graduate Level

Jacek F. Gieras

University of Technology and Life Sciences., Department of Electrical Engineering, 85-796 Bydgoszcz, Poland
jacek.gieras@utp.edu.pl

ABSTRACT: Magnetic levitation has been included in the content of the graduate course “Electromechanical Energy Conversion” at the University of Technology and Life Sciences, Bydgoszcz, Poland, since 1978. The article presents small-scale laboratory prototypes of electromagnetic (EML) and electrodynamic (EDL) levitation systems, which are used for teaching purposes. Introduction of magnetic levitation to the “Electromechanical Energy Conversion” graduate course attracts more students and make this difficult course more interesting to them.

1 INTRODUCTION

The author would like to share his experience in teaching magnetic levitation in the Department of Electrical Engineering at graduate level. Magnetic levitation is a part of graduate course “Electromechanical Energy Conversion” being taught since 1978. Three lecture hours out of 30 hours in total are devoted to the electromagnetic (EML) and electrodynamic (EDL) levitation effects and their applications in high speed transportation. Electromechanical Energy Conversion Laboratory is equipped with variety of small-scale prototypes of EML and EDL devices and system.

2 COURSE STRUCTURE

The course curriculum is briefly described in Table 1. The course is divided into three parts: (1) circuital approach to analysis of electromechanical devices and systems, (2) electromagnetic field theory, (3) linear motors and magnetic levitation as examples of electromechanical systems. In addition to 30 lectures, 6 laboratory sessions support this course: (1) Repulsive and attractive forces of electromagnets, (2) Measurements of magnetic field distribution in the air

gap of an ac. electrical machine, (3) Finite element method analysis of simple electromechanical devices, (4) Linear induction motor, (5) Linear synchronous motor, (6) EML and EDL systems (demonstration). All laboratory test benches have been built in the Electrical Engineering Department (Electrical Machines and Drives Group).

Table. 1. “Electromechanical Energy Conversion” – graduate course at University of Technology and Life Sciences.

Part	Topic	Lecture hours
1	Hamilton’s principle	3
	Basic coordinates and parameters of systems	3
	Energies in process of conversion	3
	Electrical and mechanical balance equations in ABC, α - β , and d - q reference frames	3
	Transformation of voltages, currents and fluxes in different reference frames	2
2	Fundamental equations of electromagnetic field	3
	Forces in electromagnetic field	2
	Electromagnetic power, Poynting vector	2
	Analysis of electromagnetic field in conductive bodies	
	Fundamentals of Finite Element Method	3
3	Linear electric motors	3
	Magnetic levitation	3

Introduction of linear motors and magnetic levitation makes the “Electromechanical Energy Conversion” course much more attractive to students than in the case of using classical electrical machines as examples and laboratory equipment.

In the next sections, laboratory equipment for demonstration of EML and EDL will be discussed.

3 ELECTROMAGNETIC LEVITATION

The simplest equipment is an axial-symmetry electromagnet with coils connected in such a way as to produce magnetic fluxes in opposite direction (Figures 1 and 2). This electromagnet can produce quite large repulsive forces and can find practical applications, e.g., in electromagnetically-actuated bottle jacks. Repulsive forces as functions of the power consumption are plotted in Figure 3. The outside diameter of the electromagnet is 240 mm.

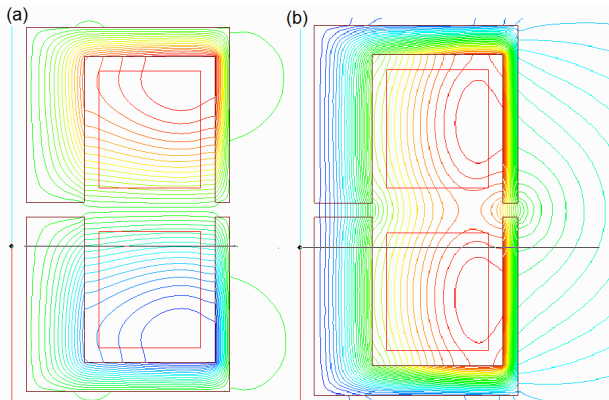

Figure 1. Magnetic flux distribution in one half of axial-symmetry electromagnet producing: (a) repulsive forces, (b) attraction forces.

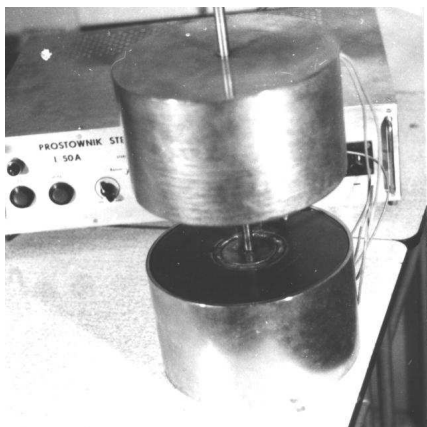

Figure 2. Electromagnet for testing repulsive forces.

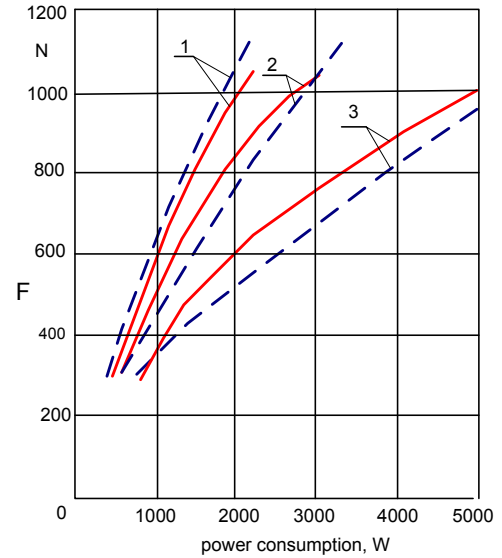

Figure 3. Repulsive forces of the electromagnet shown in Figure 3 as functions of power consumption. 1- air gap $g = 10$ mm, 2 – air gap $g = 20$ mm, 3 – air gap $g = 40$ mm. Solid line – current without pulsation. Dashed line – current from single phase rectifier.

Figure 4 shows an EML system with controlled air gap. Equation for attraction force between U-shaped electromagnet and steel plate has been derived including the magnetic voltage drop in the ferromagnetic core (magnetic saturation) and fringing flux, i.e.,

$$F_z = \frac{\mu_0 S_g (iN)^2}{4 \left(\frac{l_{Fe}}{2\mu_r S_{Fe} / S_g} + g + z \right)^2} \quad (1)$$

where $\mu_0 = 0.4\pi \times 10^{-6}$ H/m, μ_r is the relative magnetic permeability of the ferromagnetic core, S_g is the cross section area of the air gap, S_{Fe} is the cross section area of the ferromagnetic core, l_{Fe} is the length of the magnetic flux path in the ferromagnetic core and steel plate, g is the air gap, z is the vertical coordinate, i is the current and N is the number of turns.

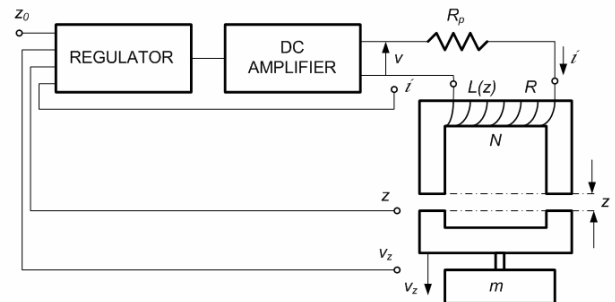

Figure 4. EML system: z_0 - required air gap, z - actual air gap, v_z - speed of the electromagnet in the z -direction, m – part being suspended.

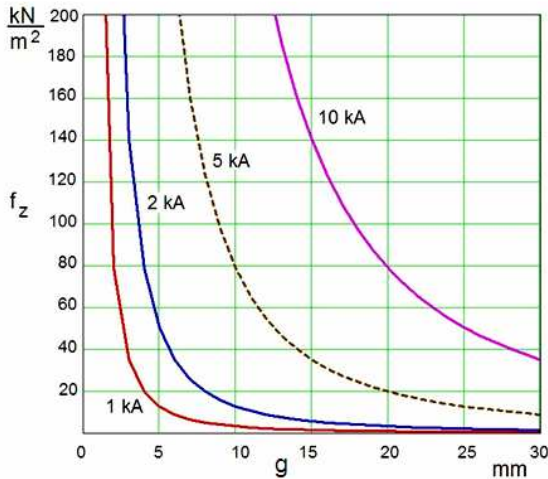

Figure 5. Force density f_z plotted against the air gap g at constant MMF $iN = 1, 2, 5$ and 10 kA.

Neglecting the magnetic saturation and assuming $S_{Fe} \approx S_g$ the attraction force per unit area of the air gap, i.e., the force density is

$$f_z = \frac{F_z}{S_g} \approx \frac{\mu_0 (iN)^2}{4g^2} \text{ N/m}^2 \quad (2)$$

Figure 5 show the force density f_z plotted against the air gap g at constant MMF $iN = \text{constant}$.

For small fluctuations of the air gap g and current i , the force F_z can be expressed as a linear function of the air gap and current, i.e.,

$$F_z = -k_1 z + k_2 i = -m \frac{d^2 z}{dt^2} \quad (3)$$

where k_1, k_2 are constants and m is the suspended mass. With zero initial conditions $z(0) = 0, z'(0) = 0$ eqn (3) can be brought to the form

$$m s^2 Z(s) = k_1 Z(s) - k_2 i(s) \quad (4)$$

If the transfer function of the amplifier in Figure 4 is expressed as $i(s)/u(s) = k_3/(1+sT_m)$, where $u(s)$ is the control vottage signal, T_m is the amplifier time constant, and, k_3 is a constant, the transfer function of the EML system is

$$\frac{Z(s)}{u(s)} = \frac{-k_2 k_3}{m(1+sT_m) \left(s^2 - \frac{k_1}{m} \right)} \quad (5)$$

Position of poles in eqn (5) shows that the system is unstable even at unlimited increase in $k_2 k_3$ or amplification factor of the position transducer. To provide adequate reserve of stability, accuracy and fast reaction, a corrective element (compensator) between the position transducer and power amplifier is necessary.

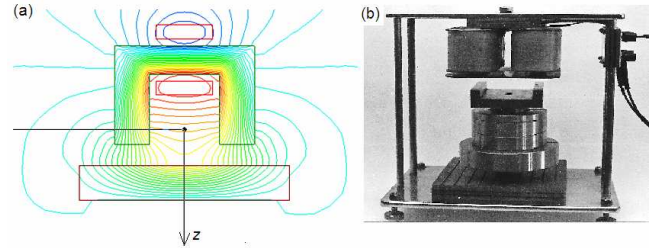

Figure 6. Electromagnet with controlled air gap for testing EML forces: (a) magnetic flux distribution, (b) prototype.

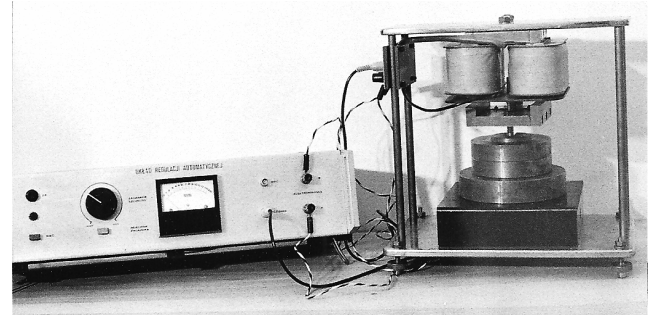

Figure 7. Laboratory set up for testing EML forces.

The laboratory equipment for measurements of EML forces is shown in Figures 6 and 7. This simple physical model explains the principle of operation of German *Transrapid* maglev high speed train and Japanese HSST maglev urban transit system.

4 ELECTRODYNAMIC LEVITATION

A very simple and effective teaching tool for EDL is an aluminum boat-shaped object (small-scale vehicle) suspended, propelled and stabilized by the electromagnetic field excited by a long-primary transverse flux linear induction motor (TF LIM).

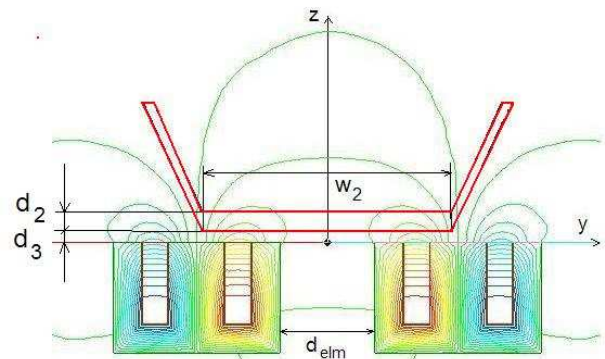

Figure 8: Suspension of a conductive nonferromagnetic secondary in the shape of a boat with flat bottom in the magnetic field produced by a TF LIM (cross section).

If the primary winding of a flat TFLIM is fed with an a.c. current, a conductive paramagnetic or diamagnetic plate will be suspended above the primary core [1-10]. Lateral stabilization forces will be produced if the conductive plate (the secondary) is appropriately shaped [1,2]. It is possible to design the secondary as a “vehicle” suspended and propelled by electromagnetic field of a LIM. Figures 8 and 9 show the secondary shaped as a boat with flat bottom of a TF LIM [3-5,7-9].

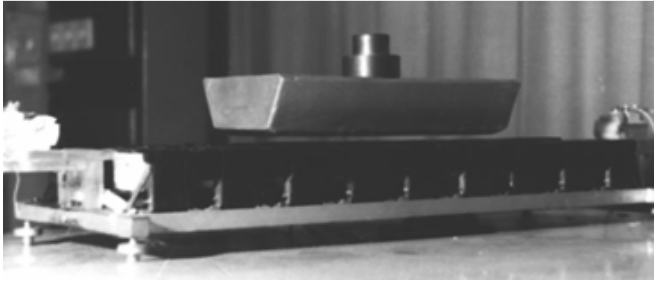

Figure 9. Laboratory demonstration of EDL effect.

The electrodynamic force F_z in the z-direction (suspension force) can be calculated on the basis of Lorentz equation. It has been derived in [3,7,8].

In the most recent laboratory prototype of the TFLIM with the secondary suspended, propelled and stabilized electro-dynamically, the primary consists of 36 electromagnets with E-shape cores distributed in two rows (Fig. 10). The length of the track is 1450 mm and its width is 216 mm. The dimensions of the E-shape cores are: 56-mm height, 84-mm width, 40-mm thickness, 28-mm width of the center leg, 14-mm width of the external leg, and 14-mm height of the bottom yoke. The number of turns per electromagnet is $N = 177$ and the diameter of round wire without insulation is 1.3 mm. The class of insulation is 220°C. The current density at 20 A *rms* is 15 A/mm². A forced air cooling system with electric motor-driven blower has been applied. The maximum air flow can achieve 255 m³/h.

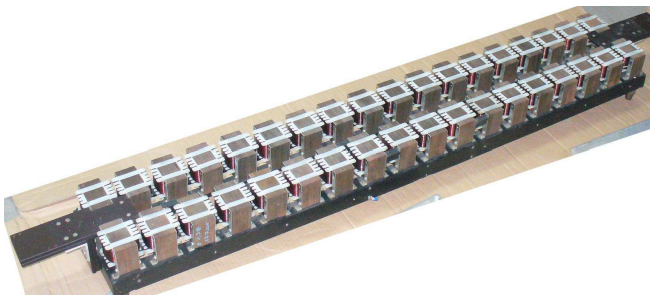

Figure 10: The primary of the TF LIM consisting of 36 E-type electromagnets distributed in two rows.

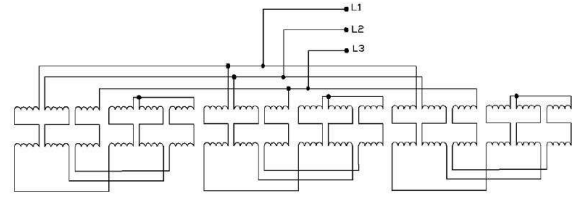

Figure: 11. Connection diagram of the primary coils to obtain unidirectional traveling magnetic field along the whole track (primary).

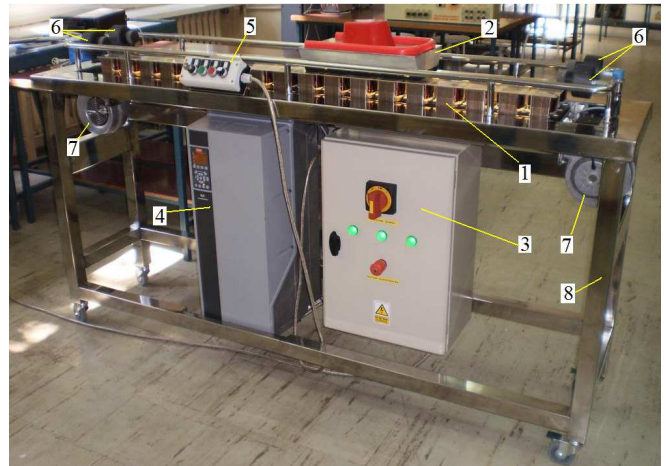

Figure 12: Laboratory set-up for demonstration of EDL effect using a special TF LIM: 1 – primary (electromagnets), 2 – secondary, 3 – main switch and safety switch box, 4 – solid-state inverter, 5 – control unit, 6 – limit sensors, 7 – blowers, 8 – frame.

The connection diagram of electromagnet coils is shown in Figure 11. Coils in Figure 11 are connected in such a way as to obtain the traveling magnetic field along the whole length of the primary. It is also possible to connect the coils to produce only a pulsating magnetic field (single-phase excitation) or two traveling fields in opposite direction. Thus, in the second case, the secondary is kept in a stable, center position of the track (Figure 9). More details are shown in Figure 12.

The EDL force F_z is very sensitive to the thickness d_2 of the aluminum bottom of the secondary unit and the air gap d_3 between the surface of electromagnets and the aluminum secondary (Figure 13). The smaller the air gap and the thicker the secondary bottom, the higher the EDL force F_z . The electric conductivity of the secondary and its fluctuation with temperature also strongly affect the suspension force F_z . Another important effect is the so called *edge effect* that must be taken into account in calculations of the EDL force F_z .

Comparison of calculation of the suspensions force F_z with test results is shown in Figure 14.

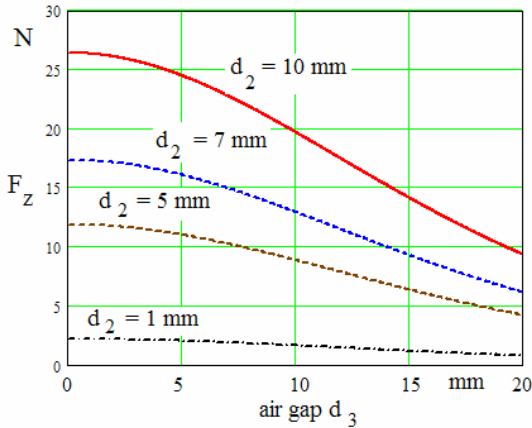

Figure 13. Electrodynamic suspension force as a function of the air gap d_3 for four different thicknesses $d_2 = 10; 7; 5;$ and 1 mm of the secondary bottom at 300 V and 50 Hz. Calculation results on the basis of Lorentz equation [7,8].

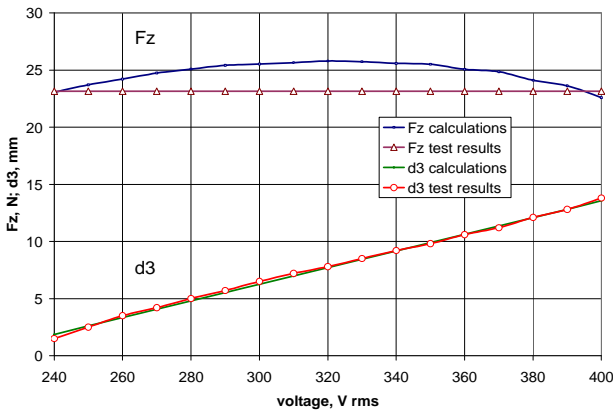

Figure 14. Comparison of calculations of the suspension force F_z and air gap d_3 with measurements at $f = 50$ Hz and temperature of the secondary $\theta_2 = 75^\circ$ C for fundamental space harmonic of the electromagnetic field.

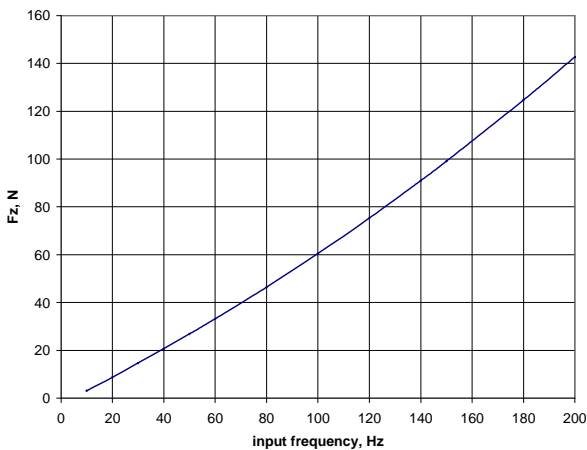

Figure: 15. Influence of the input frequency on the suspension force F_z . Calculation results for $V = 300$ V rms, $f = 50$ Hz, $\theta_2 = 75^\circ$ C, $d_2 = 10$ mm, $d_3 = 5$ mm, and fundamental harmonic of the electromagnetic field.

As the input frequency increases, the suspension force F_z increases too (Figure 15). If the frequency is doubled, the force F_z increases more than twice. Approximately, the suspension force due to fundamental harmonic of the electromagnetic field changes with the input frequency as $F_z = 0.202 f^{1.24}$. Higher space harmonics practically have no influence on the suspension force F_z [8].

The laboratory prototype of the TF LIM (Figure 12) for the demonstration of EDL effect helps students to understand the principle of operation of the EDL maglev train on the Yamanashi Maglev Test Line (YMTL). Although, the YMTL uses superconducting electromagnets, the repulsive forces are produced in a similar way. This prototype plays also important role in public awareness of the EDL effect (University *Open Door*, science festivals, exhibitions, science education, amusement parks, etc.). Precision manufacturing industry and defense forces have shown interest in TF LIMs with the secondary suspended electro-dynamically.

5 OTHER SMALL-SCALE PROTOTYPES

Teaching and demonstration of magnetic levitation is not limited to prototypes discussed in Sections 3 (EML) and 4 (EDL). Examples of other prototypes built as students' projects are shown in Figures 16 and 17.



Figure 16. Prototype of an EDL people mover suspended, propelled and stabilized using a V-shaped LIM.



Figure 17. Prototype of a LIM-driven people mover with permanent magnet repulsive suspension system.

6 CONCLUSIONS

Magnetic levitation has been taught at the University of Technology and Life Sciences since 1978 as a part of “Electromechanical Energy Conversion” graduate course. Three lecture hours out of 30 in total (Table 1) are devoted to the EML and EDL effects and their applications in high speed transportation

The EML system has been presented to students using electromagnets producing repulsive forces and U-shaped electromagnets with controlled air gap. Laboratory test benches (Figures 6 and 7) have been used to explain students the principle of operation of *Transrapid* maglev train and HSST urban transit system.

A very simple and effective teaching tool for EDL is an aluminum boat-shaped object (small-scale vehicle) suspended, propelled and stabilized by electromagnetic field excited by a long-primary TF LIM (Figures 8 – 12). The TF LIM for the demonstration of EDL effect helps students to understand the principle of operation of high speed maglev trains on the YMTL.

Introduction of linear motors and magnetic levitation to “Electromechanical Energy Conversion” course has made this course more attractive to graduate students. Problems regarded as difficult and sometimes boring, e.g., Hamilton’s principle, Euler-Lagrange equation, Maxwell equations, etc., can become interesting to young people, if illustrated with modern power engineering technologies.

Power point presentations, small-scale prototypes (Figures 2,6,7, 9–12, 16,17) and video movies have been frequently used in the teaching process. In students’ opinion (course evaluation sheets), magnetic levitation was the highest value and most interesting topic in the “Electromagnetic Energy Conversion” course.

7 REFERENCES

- [1] J.F. Eastham and E.R. Laithwaite, “Linear induction motors as electromagnetic rivers.” *Proc. IEE*, vol. 121, pp. 1099-1108, No 10, 1974.
- [2] E. M. Freeman, D.A. Lowther, "Normal force in single-sided linear induction motors." *Proc. IEE*, vol. 120. pp. 1499-1506, No 12, 1973.
- [3] J.F. Gieras, "Electrodynamic forces in electromagnetic levitation systems." *Acta Technica CSAV*, pp. 532-545, No 5, 1982.
- [4] J.F. Gieras, "Influence of structure and material of secondary suspended electro-dynamically on steady performance characteristics of linear induction motor with transverse flux.", *etzArchiv*, vol. 6, pp. 255-260, No 7, 1984.
- [5] J. F. Gieras, *Linear induction drives*. Oxford University Press, Oxford, 1994.
- [6] J.F. Gieras, Z.J. Piech and B.Z. Tomczuk, *Linear synchronous motors*, 2nd ed. , Taylor & Francis – CRC Press, Boca Raton, 2011.
- [7] J.F. Gieras, Z. Gientkowski, J. Mews and M. Splawski, "Analytical calculation of electrodynamic levitation forces in a special-purpose linear induction motor." *Int. Elec. Machines and Drives Conf. IEMDC'11*, Niagara, Fall, Canada, 2011.
- [8] F. Gieras, Z. Gientkowski, J. Mews and M. Splawski, "Analysis of a Transverse-Flux LIM with Magnetically Suspended Reaction Plate." *Int. Symp. on Linear Drives for Industry Applications LDIA'11*, Eindhoven, The Netherlands, 2011.
- [9] P. Hochhausler, "Der Katamaran als magnetisches Schwebefahrzeug." *ETZ B*, vol 26, pp. 412-413, No 3, 1973.
- [10] B. V. Jayawant, *Electromagnetic levitation and suspension techniques*, London: E. Arnold, 1981.